

ÇİFT TARAF AÇILI MAFSALLI ŞERİT TESTERE MAKİNA MODELLERİ

BMSY 440 DGH / BMSY 440 DGH NC
BMSY 360 DGH - BMSY 360 DGH ECO
BMSY 270 DGH - BMSY 270 DG - BMS 270 DG
BMSY 230 DGH - BMSY 230 DG - BMS 230 DG

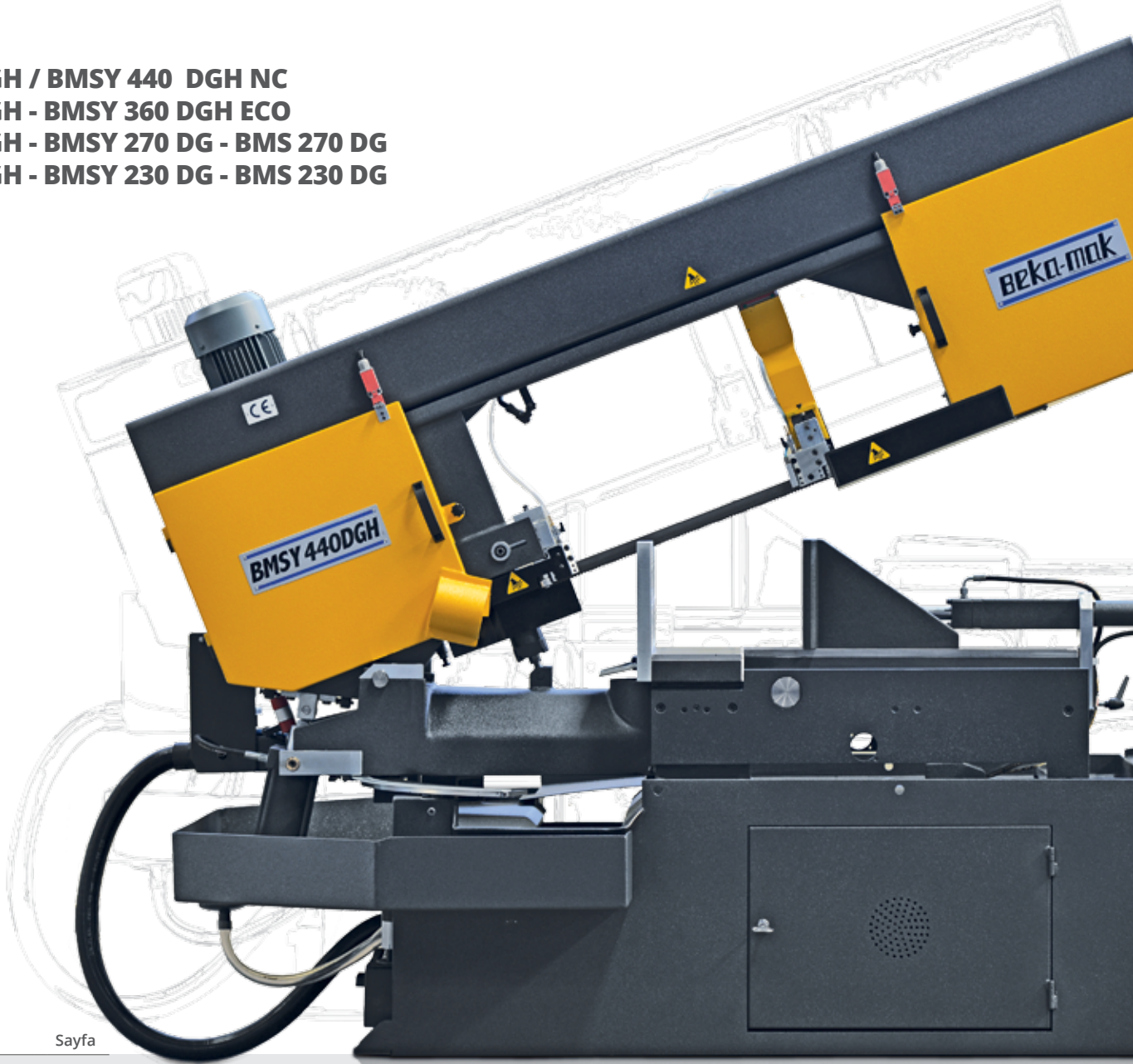

Model	Sayfa
BMSY 440 DGH / DGH NC	90
BMSY 360 DGH	92
BMSY 360 DGH ECO	93
BMSY 270 DGH	94
BMSY 270 DG	94
BMS 270 DG	95
BMSY 230 DGH	96
BMSY 230 DG	96
BMS 230 DG	97

BMSY 440 DGH / DGH NC

Çift Tarafa Açılı Mafsallı Şerit Testere Makinası

Standartlar







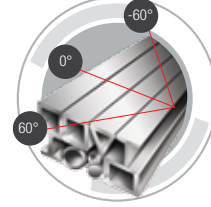

Şerit Testere Bıçağı 34
Kumando Panosu
Talaş Firçası
Hız Kontrol Cihazı
Kapak Swich
Hidro Mekanik Şerit Germe
Lineer Kızaklı kol
Hidrolik Mengene
Vibrasyon Önleyici Silindir
Yükseklik Ayar Sensörü
Planet Redüktör
SAP Boryağ Pompası
Hidrolik Mengene Gezdirme Sistemi
Hassas Basınç Ayarı
Nc Kontrol Paneli
Açıya Gidiş Sireni

Opsiyonel

Hidrolik Şerit Germe
Yükseklik Ayar Sensörü
3 Mt Motorlu Sehpa
3 mt Malzeme Sehpası
Lazer İşaretleyici
Mikrosprey Soğutucu



Teknik Özellikler

	BMSY 440 DGH				BMSY 440 DGH NC			
								
Kesme Kapasitesi	0°	-	440 x 610	440	0°	440	440 x 610	440
	30°	440	440 x 500	440	30°	440	440 x 500	440
	45°	410	440 x 410	410	45°	410	440 x 410	410
	60°	320	440 x 250	250	60°	320	440 x 250	250
	-30°	440	440 x 500	440	-30°	440	440 x 500	440
	-45°	410	440 x 410	410	-45°	410	440 x 410	410
	-60°	320	440 x 285	285	-60°	320	440 x 285	285
Ana Motor	3 kW				3 kW			
Hidrolik Motor	0,55 kW				0,55 kW			
Soğutucu Motor	0,12 kW				0,12 kW			
Kesme Hızları	20 - 100 m/min				20 - 100 m/min			
Şerit Testere Ölçüsü	5000 x 34 x 1,1 mm				5200 x 34 x 1,1 mm			
Malzeme Besleme Yüksekliği	860 mm				860 mm			
Ebatlar	Uzunluk 2750 mm Genişlik 1210 mm		Yükseklik 1870 mm Ağırlık 1195		Uzunluk 2800 mm Genişlik 1210 mm		Yükseklik 1870 mm Ağırlık 1640 kg	

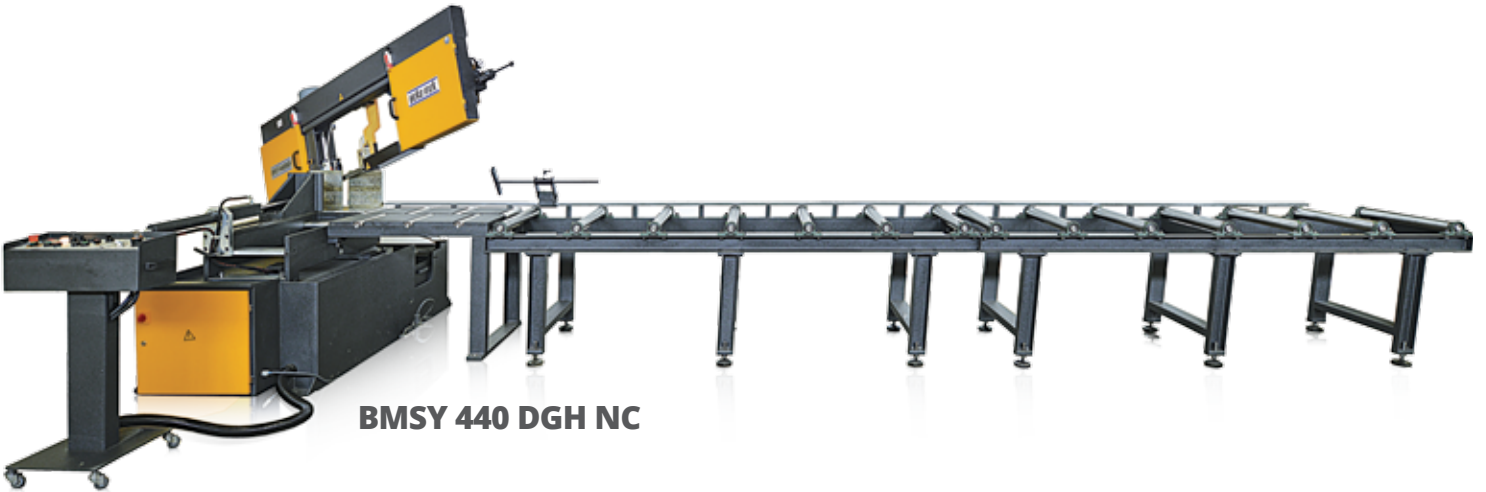

BMSY 440 DGH NC

Hidrolik Şerit Germe



Yükseklik Ayar Sensörü



3 Mt Motorlu Sehpa



3 mt Malzeme Sehpa



Lazer İşaretleyici



Mikrosprey Soğutucu



BMSY 360 DGH - BMSY 360 DGH ECO

Çift Tarafa Açılı Mafsallı Şerit Testere Makinası

Standartlar

Şerit Testere Bıçağı 34
Hassas Basınç Ayarı
Hız Kontrol Cihazı
Talaş Fıçası
Kapak Swich
Hidro Mekanik Şerit Germe
Lineer Kızaklı kol
Hidrolik Mengene

Vibrasyon Önleyici Silindir
Kontrol Paneli
Planet Redüktör
SAP Boryağ Pompası
Yükseklik Ayar Swich
Dijital Açı Göstergesi
Hareketli Kumanda

Opsiyonel

Hidrolik Şerit Germe
Yükseklik Ayar Sensörü
3 Mt Motorlu Sehpa
3 mt Malzeme Sehpa
Lazer İşaretleyici
Mikrosprey Soğutucu

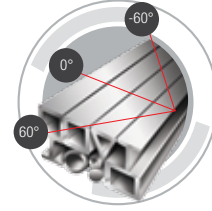

Hidrolik Şerit Germe



Yükseklik Ayar Sensörü



3 Mt Motorlu Sehpa



3 mt Malzeme Sehpa











Lazer İşaretleyici



Mikrosprey Soğutucu



Teknik Özellikler

	BMSY 360 DGH				BMSY 360 DGH ECO			
								
Kesme Kapasitesi	0°	360	610 x 360	360	0°	360	510 x 360	360
	30°	360	610 x 360	360	30°	360	510 x 360	360
	45°	360	490 x 360	360	45°	360	390 x 360	360
	60°	340	300 x 360	300	60°	200	200 x 360	200
	-30°	360	610 x 360	360	-30°	360	510 x 360	360
	-45°	360	490 x 360	360	-45°	360	390 x 360	360
	-60°	360	360 x 360	360	-60°	260	260 x 360	260
Ana Motor	3 kW				3 kW			
Hidrolik Motor	0,55 kW				0,37 kW			
Soğutucu Motor	0,12 kW				0,12 kW			
Kesme Hızları	20 - 100 m/min				20 - 100 m/min			
Şerit Testere Ölçüsü	5000 x 34 x 1,1 mm				4800 x 34 x 1,1 mm			
Malzeme Besleme Yüksekliği	860 mm				860 mm			
Ebatlar	Uzunluk 2750 mm Genişlik 1210 mm		Yükseklik 1870 mm Ağırlık 1470		Uzunluk 2800 mm Genişlik 1210 mm		Yükseklik 1870 mm Ağırlık 1450 kg	

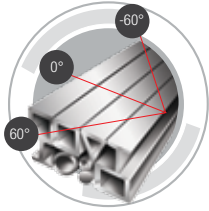

BMSY 270 DGH - BMSY 270 DG

Çift Taraflı Açılı Mafsallı Şerit Testere Makinası
DGH - Hidrolik Mengene Standart

Standartlar

Şerit Testere Bıçağı 27
Yükseklik Ayar Swich
Planet Redüktör
Sap Boryağ Pompası
Ayak Pedalı
Kumando Panosu
Dayama
Hidromekanik Şerit Germe
Talaş Fırçası
Kapak Swich

Opsiyonel

3 Mt Malzeme Sehpa
Hız Kontrol Cihazı
Mikrosprey Soğutucu



BMSY 270 DGH



BMSY 270 DG

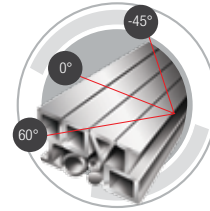

BMS 270 DG

Çift Tarafa Açılı Manuel Mafsallı Şerit Testere Makinası

Standartlar

Hidromekanik Şerit Germe
Mengene
Siti Redüktör
Şerit Testere Bıçağı 27
Hız Kontrol Cihazı
Talaş Fırçası
Kapak Swich
Dayama
SAP Boryağ pompası
Kontrol Panel

Opsiyonel

3 Mt Malzeme Sehpa
Mikrosprey Soğutucu

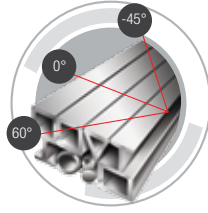

Teknik Özellikler

	BMSY 270 DGH				BMSY 270 DG				BMS 270 DG			
	△	○	□	□	△	○	□	□	△	○	□	□
Kesme Kapasitesi	0°	270	350x220	270	0°	270	350x220	270	0°	270	350x220	270
	45°	240	270x200	170	45°	240	270x200	170	45°	240	270x200	170
	60°	150	150x100	100	60°	150	150x100	100	60°	150	150x100	100
	-45°	210	270x210	180	-45°	210	270x210	180	-45°	210	270x210	180
Ana Motor	1,5 kW				1,5 kW				1,5 kW			
Hidrolik Motor	0,37 kW				0,37 kW				-			
Soğutucu Motor	0,12 kW				0,12 kW				0,12 kW			
Kesme Hızları	20 - 100 m/min				20 - 100 m/min				20 - 100 m/min			
Şerit Testere Ölçüsü	3160x27x0,9 mm				3160x27x0,9 mm				3160x27x0,9 mm			
Malzeme Besleme Yüksekliği	910 mm				910 mm				910 mm			
Ebatlar	Uzunluk 1730 mm Genişlik 770 mm		Yükseklik 1460 mm Ağırlık 525 kg		Uzunluk 1730 mm Genişlik 770 mm		Yükseklik 1460 mm Ağırlık 476 kg		Uzunluk 1730 mm Genişlik 770 mm		Yükseklik 1460 mm Ağırlık 465 kg	

3 Mt Malzeme Sehpa



Hız Kontrol Cihazı



Mikrosprey Soğutucu



BMSY 230 DGH - BMSY 230 DG

Çift Tarafa Açılı Mafsallı Şerit Testere Makinası
DGH - Hidrolik Mengene Standart

Standartlar

Şerit Testere Bıçağı 27
Hız Kontrol Cihazı
Talaş Firçası
Hidromekanik Şerit Germe
Kapak Swich
Mengene
Kumando Panosu
SAP Boryağ Pompası
Planet Redüktör
Yükseklik Ayar Swich
Dayama

Opsiyonel

3 Mt Malzeme Sehpa
Hız Kontrol Cihazı
Mikrosprey Soğutucu

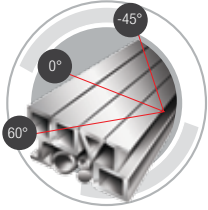

BMSY 230 DGH



BMSY 230 DG

BMS 230 DG

Çift Tarafa Açılı Mafsallı Şerit Testere Makinası

Standartlar

Şerit Testere Bıçağı 27
Yükseklik Ayar Swich
Hidromekanik Şerit Germe
SAP Boryağ Pompası
Talaş Fırçası
Dayama
Kapak Swich
Kumanda Panosu
Hareketli Mengene

Opsiyonel

3 Mt Malzeme Sehpa
Hız Kontrol Cihazı
Mikrosprey Soğutucu

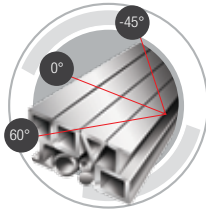

Teknik Özellikler

	BMSY 230 DGH				BMSY 230 DG				BMS 230 DG			
	△	○	□	□	△	○	□	□	△	○	□	□
Kesme Kapasitesi	0°	230	320 x 130	230	0°	230	320 x 130	230	0°	230	320 x 130	230
	-45°	180	230 x 160	150	-45°	180	230 x 100	150	-45°	180	230 x 100	150
	45°	210	230 x 160	180	45°	210	230 x 160	180	45°	120	230 x 160	180
	60°	120	120 x 100	100	60°	120	120 x 100	100	60°	120	120 x 100	100
Ana Motor	1,0 - 1,3 kW				1,0 - 1,3 kW				1,0 - 1,3 kW			
Hidrolik Motor	0,37 kW				0,37 kW				-			
Soğutucu Motor	0,12 kW				0,12 kW				0,12 kW			
Kesme Hızları	35 - 70 m/min				35 - 70 m/min				35 - 70 m/min			
Şerit Testere Ölçüsü	2730 x 27 x 0,9 mm				2730 x 27 x 0,9 mm				2730 x 27 x 0,9 mm			
Malzeme Besleme Yüksekliği	760 mm				760 mm				760 mm			
Ebatlar	Uzunluk 1350 mm Genişlik 700 mm		Yükseklik 1300 mm Ağırlık 465 kg		Uzunluk 1350 mm Genişlik 700 mm		Yükseklik 1300 mm Ağırlık 430 kg		Uzunluk 1350 mm Genişlik 700 mm		Yükseklik 1300 mm Ağırlık 415 kg	

3 Mt Malzeme Sehpa



Hız Kontrol Cihazı



Mikrosprey Soğutucu



